

Make it with

TOWELS



EDUCATIONAL DEPARTMENT  
**CANNON MILLS, INC.**

70 WORTH STREET  
NEW YORK 13, N. Y.



# MAKE IT WITH

# TOWELS

For you . . . a fresh grab-bag of delights to make from towels and such. Take your pick . . . all sorts of new ideas!

You've told us that these towel novelties are *super* . . . for birthday gifts . . . as happy surprises . . . for kitchen showers . . . for "I-made-it-for-you" Christmas offerings . . . as amusing little stocking stuffers.

You've discovered how easily these towel gadgets sell for your fund-raising projects . . . for bazaars . . . for club, school, church, community activities! Fun to make . . . fun to receive . . . and everyone enjoys them.

Try making up some of these towel tricks . . . they'll come in handy for so many occasions. Start with something for yourself and count the "oh's" and "ah's" that come your way!

Then you'll know why these easy-to-make towel novelties prove success stories every time a clever gal takes needle in hand!

(Sewing Directions, courtesy of J. & P. Coats and Clark's O. N. T. Threads.)



## STRINGS ATTACHED TO THIS

# Terry Tie-on

This new, smart tie-on towel wrap, easy to sew, takes three Cannon bath towels. For summer, it's useful to wrap on after bathing. For year 'round, it's a handy towel-tie to slip on after tub or shower—practical because it covers you completely.

Note that the terry tie-on is fastened by a concealed hook-and-eye at the top, as shown. Fitted to the wearer and closed in this way, the wrap can be adjusted with the tie ribbons.

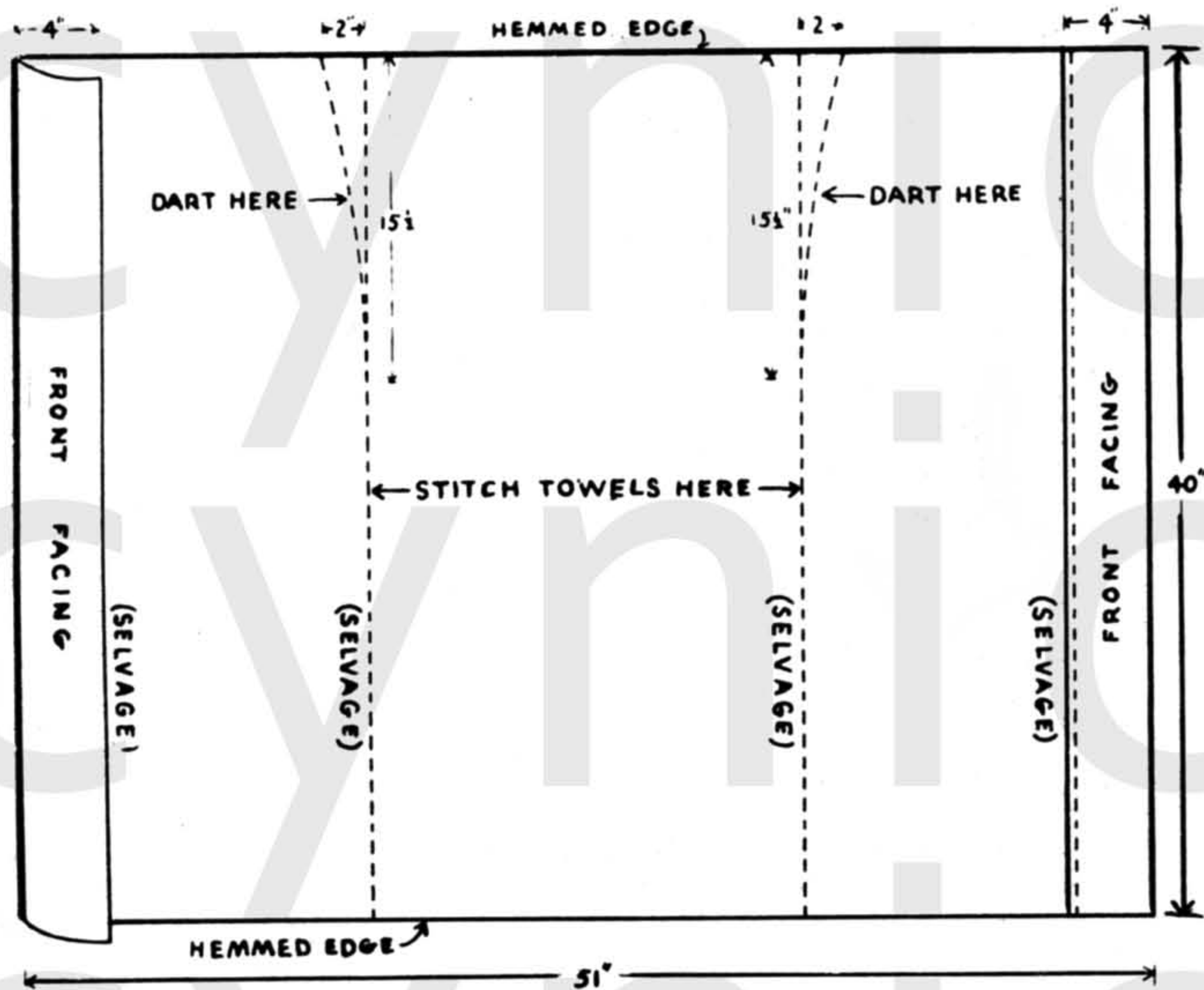

## DUNK YOUR LOCKS—IN A Shampoo Cape



What could be easier and more useful to slip on when you wash your hair? This cape is really practical—makes a wonderful gift.

You need: 1 Cannon bath towel 22" x 44"  
 $\frac{1}{4}$  yard grosgrain ribbon 1 $\frac{1}{2}$ " wide  
 1 yard grosgrain ribbon  $\frac{3}{4}$ " wide  
 Sewing thread to match

1. For neck opening, make a 6" slash across center of towel.
2. Make a 7" slash down center bind, using wide ribbon.
3. Bind remaining raw edges of opening with narrow ribbon, leaving 12" free at both ends.

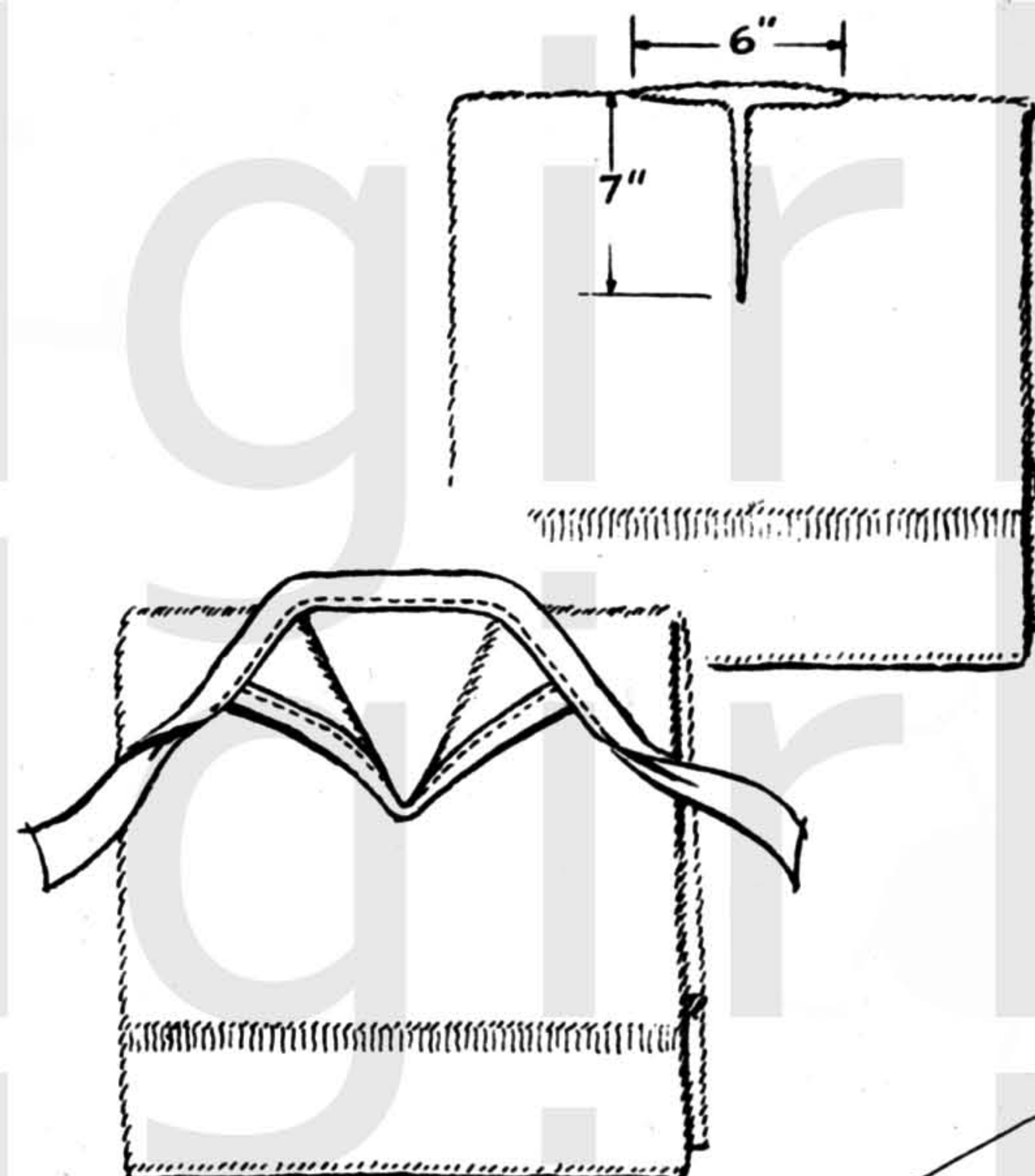

## Ballet Slippers

Aren't they attractive little slippers made of two washcloths? So easy to put together, you can have several pairs in different colors.

You need: 2 Cannon washcloths 12" x 12" or larger  
 3 yards of rug yarn for ties

1. Fold over 2 corners of a face cloth to meet and hand sew the edges flat with loose stitches. Machine stitch  $\frac{1}{2}$ " casings at fold edges.
2. Fold two pleats at a point so that their edges meet. Hand sew layers together across top. Turn point down over pleat and sew flat. Fold pleat and turn down point on opposite corner in same way.
3. Draw yarn cord through a point tab, through the casings, and cut the tab as shown. Adjust tightness and tie cord into bow.

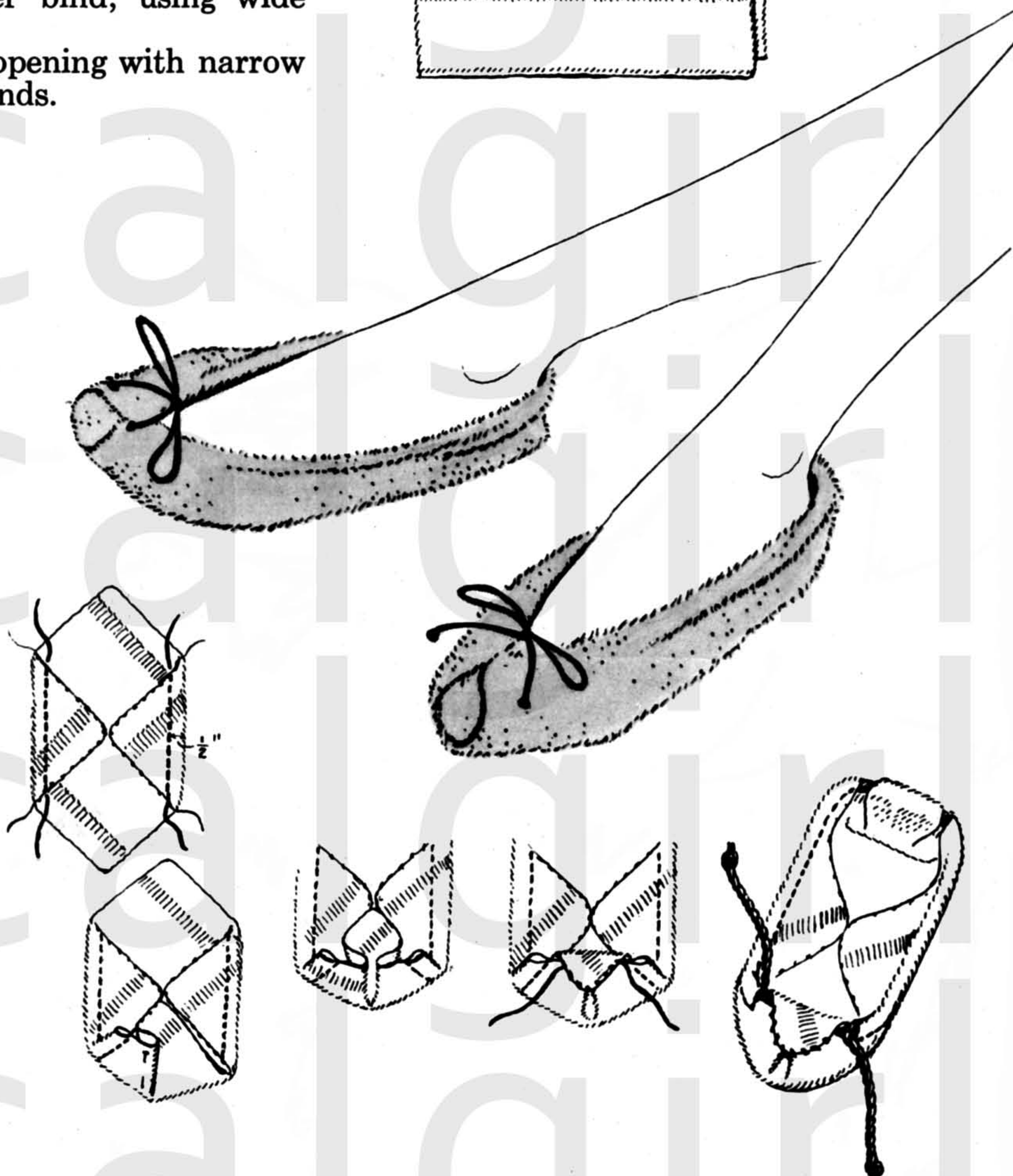

## RULE YOUR WAVES WITH A Shower Hood



Handier than any shower cap you've ever used. Keeps your hair and face completely dry.

You need: 2 Cannon washcloths 12" x 12"  
 2 pieces of plastic for lining 13 $\frac{1}{2}$ " x 13 $\frac{1}{2}$ "  
 1 yard of narrow cable cord  
 Sewing thread to match

1. Join washcloths together at two adjoining sides.
2. Join plastic pieces together in same manner.
3. Place cloths inside plastic, with wrong sides together, matching points. Pin in place.
4. Bring plastic over one edge of cloth to form hem. Leave ends open on second hem.
5. Pull cord through hem. Tie a knot at each end of cord.

# Darling Bathrobe

FOR THAT SPECIAL BABY

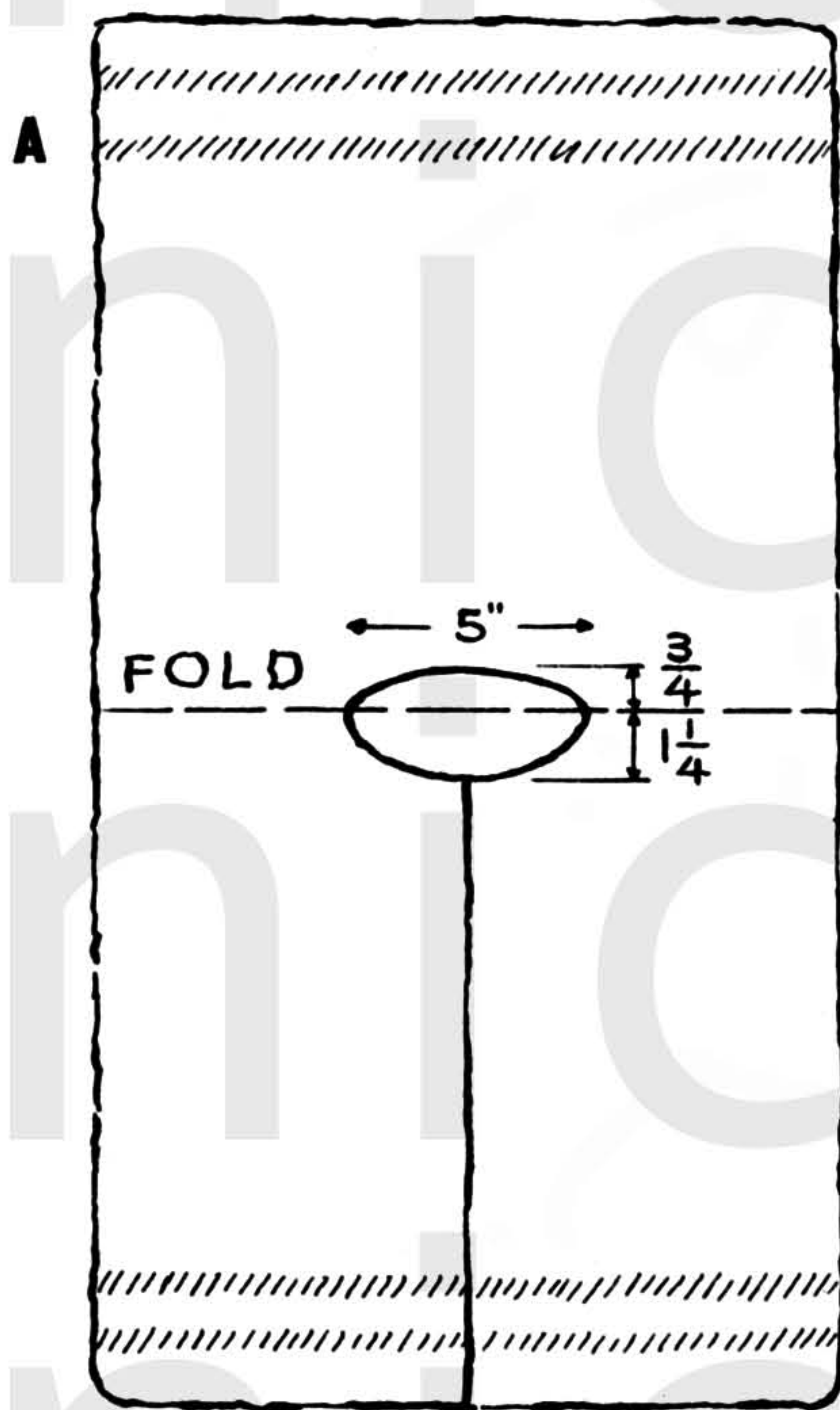

(A) Fold towel in half crosswise.

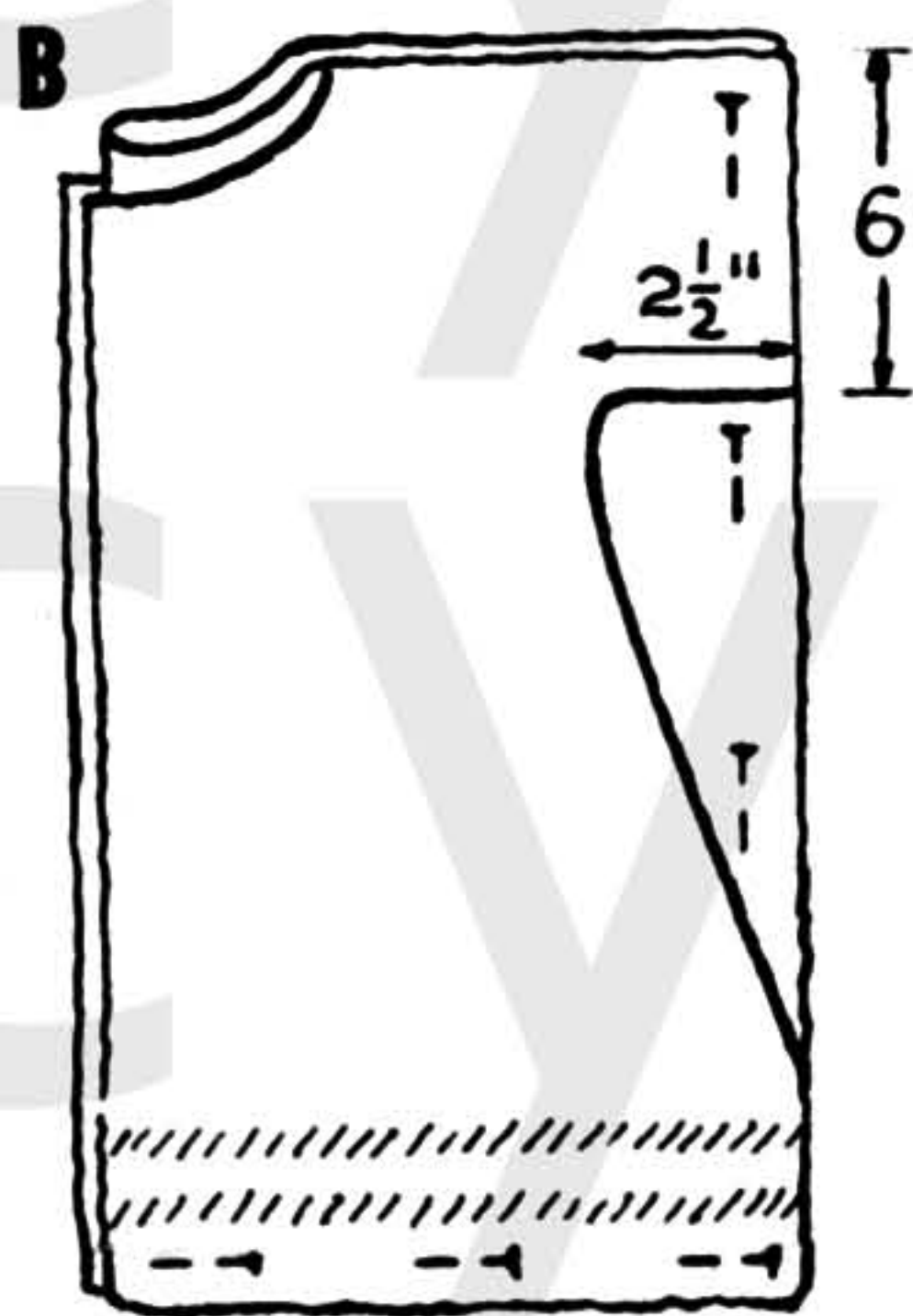

(B) Fold towel in half lengthwise. Pin selvages and lower edges together. Measure and mark as shown. Cut sloping underarm seam to top of border.

This little easy-to-make robe with a hood will fit a baby up to one year old. A wonderful gift that every mother will appreciate. You need: 1 Cannon bath towel 20" x 40"  
1 matching wash cloth 12" x 12" for hood  
2 1/2 yards cable cord No. 200  
Sewing thread to match

1. Cut as shown in diagrams.
2. For robe, make narrow hem on straight; cut edges of front of towel.
3. Make flat felled seams, joining fronts to back at underarm.
4. Make loops and stitch to underarm seams, 1" below curve.
5. For hood, fold washcloth in half, borders matching. Stitch finished edges together. Press seam open and top stitch.
6. To attach hood to robe, join cut edge of hood to neck of robe in a flat felled seam.
7. Cut a yard piece of cord. Tack center of cord to center back of neck and at center fronts.
8. Cut 4" from remainder of cord. Tack center of piece to point of hood. Fold in half and twist a thread around it, close to hood. Unravel ends.
9. Slip remainder of cord through loops at waist.
10. Fasten a thread around cord 2" from ends. Unravel ends on waist and neck cords.

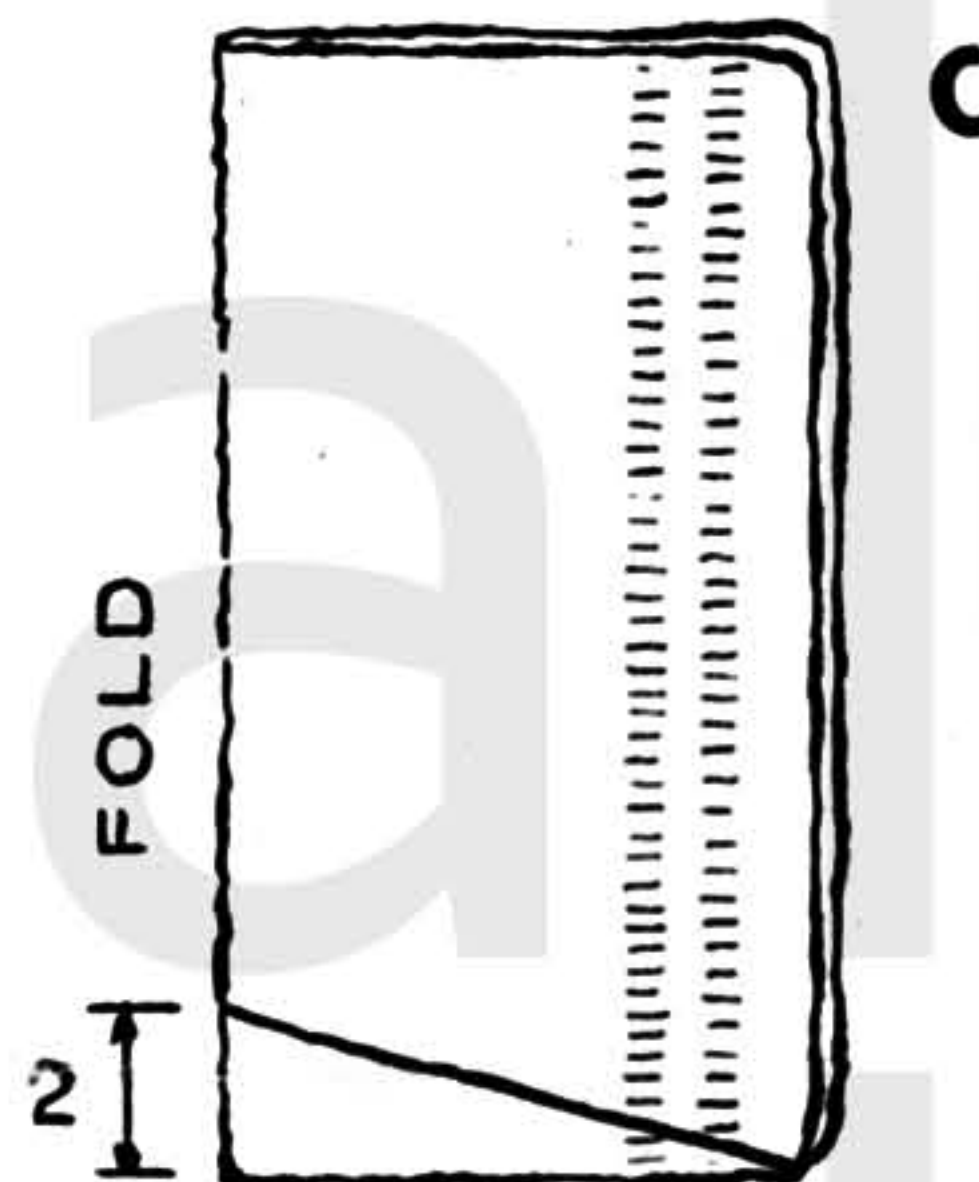

(C) Fold cloth in half, matching borders. Measure and cut across for neck. Use scraps for loops for belt.

# TRICKY Towel Apron FOR BATHING BABY

Mother wears this apron . . . lifts baby from tub and wraps him snugly in her apron-towel. She gives a slight pull . . . loosening snaps at neck and waist . . . and, presto, holds baby, warm and snug, ready to dry easily. Bath apron is so simple and handy, every baby's mother should own one.

You need: 1 Cannon bath towel 22" x 44"  
3 yards ribbon 5/8" wide  
2 snap fasteners  
Sewing thread to match

1. Cut corners, as shown.
2. Cut two pieces of ribbon, each 18" long.
3. Face cut edges, forming a loop and end at lower edge.
4. Cut a one-yard piece of ribbon for halter. Form double loops at each end.
5. Tack loop at one corner of upper edge. Sew fastener to other loop and at upper corner.
6. Form double loops at each end of ribbon to be tacked at one side of towel and snapped on other side to fit waistline.

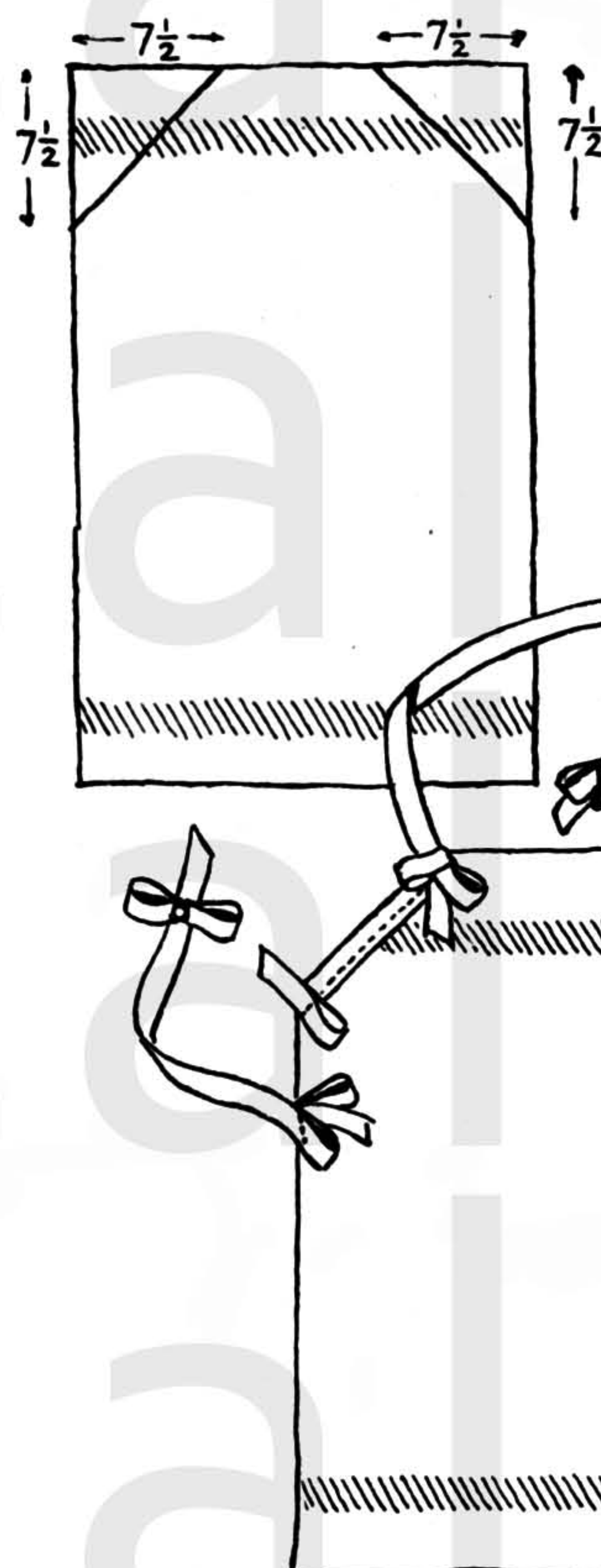

# ESKIMO COUPLE—

## Mr. + Mrs. Doll

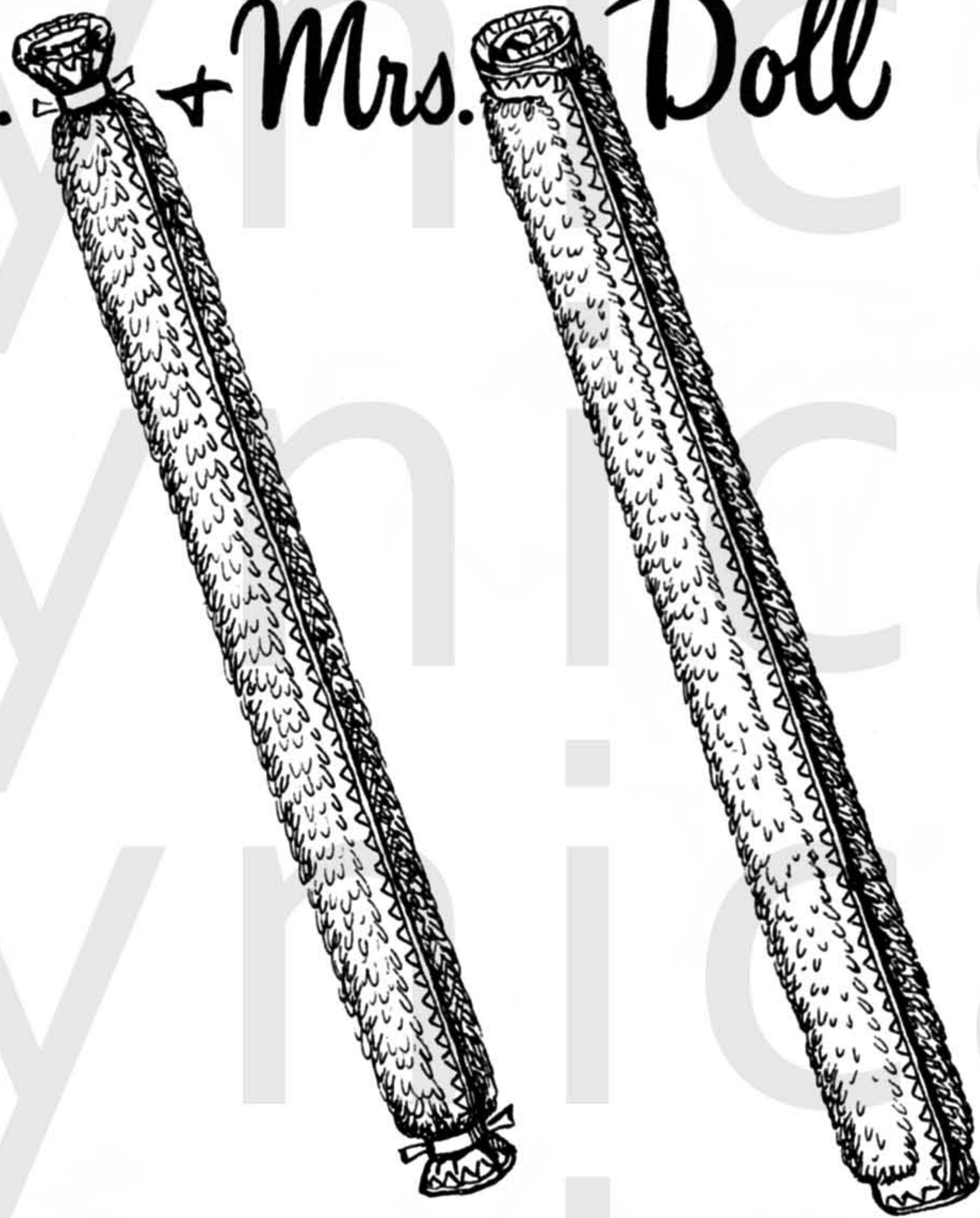

A happy pair—easy to make. You need two Cannon washcloths for each doll, plus 1 yard white ribbon  $\frac{1}{4}$ " wide for each doll. Also embroidery floss in red and black. Mr. and Mrs. make wonderful cuddle toys . . . popular novelties to make and sell for fund-raising projects.

1. Roll two washcloths tightly. For Mr. Doll, tie ends tightly with ribbon, knotting it at back of doll. For Mrs. Doll, do not tie ends.
2. Fold roll in half. Tie ribbon at waist 3" from the bottom. For Mr. have bow in back; for Mrs., at side front.
3. Fold other roll over top of first roll. Tie ribbon around neck  $2\frac{3}{4}$ " from top.
4. Embroider eyes in black and nose and mouth in red.
5. For Mrs. Doll, loosen roll at bottom to form skirt. Tack rolls together at edge.



Mr.

## FEARLESS FIDO, the Terry Terrier

Made Fido of one Cannon washcloth in about ten minutes. He's fun to make, gay to have around, especially if you stitch a silly grin on his face. Beside the washcloth, you need a half-yard of  $\frac{1}{4}$ " ribbon and embroidery floss in red and black.

1. Roll washcloth towards center.
2. Fold roll down 4". Tie ribbon tightly around neck  $1\frac{3}{4}$ " from fold.
3. Fold roll  $3\frac{1}{2}$ " from other end. Tie a ribbon tightly around roll  $1\frac{1}{4}$ " from fold, making a knot. Pull ends of ribbon up, tack to cloth. Extend ends 2", stitch together.
4. Embroider eyes and nose in black and mouth in red. Tack top of fold together to form ears.

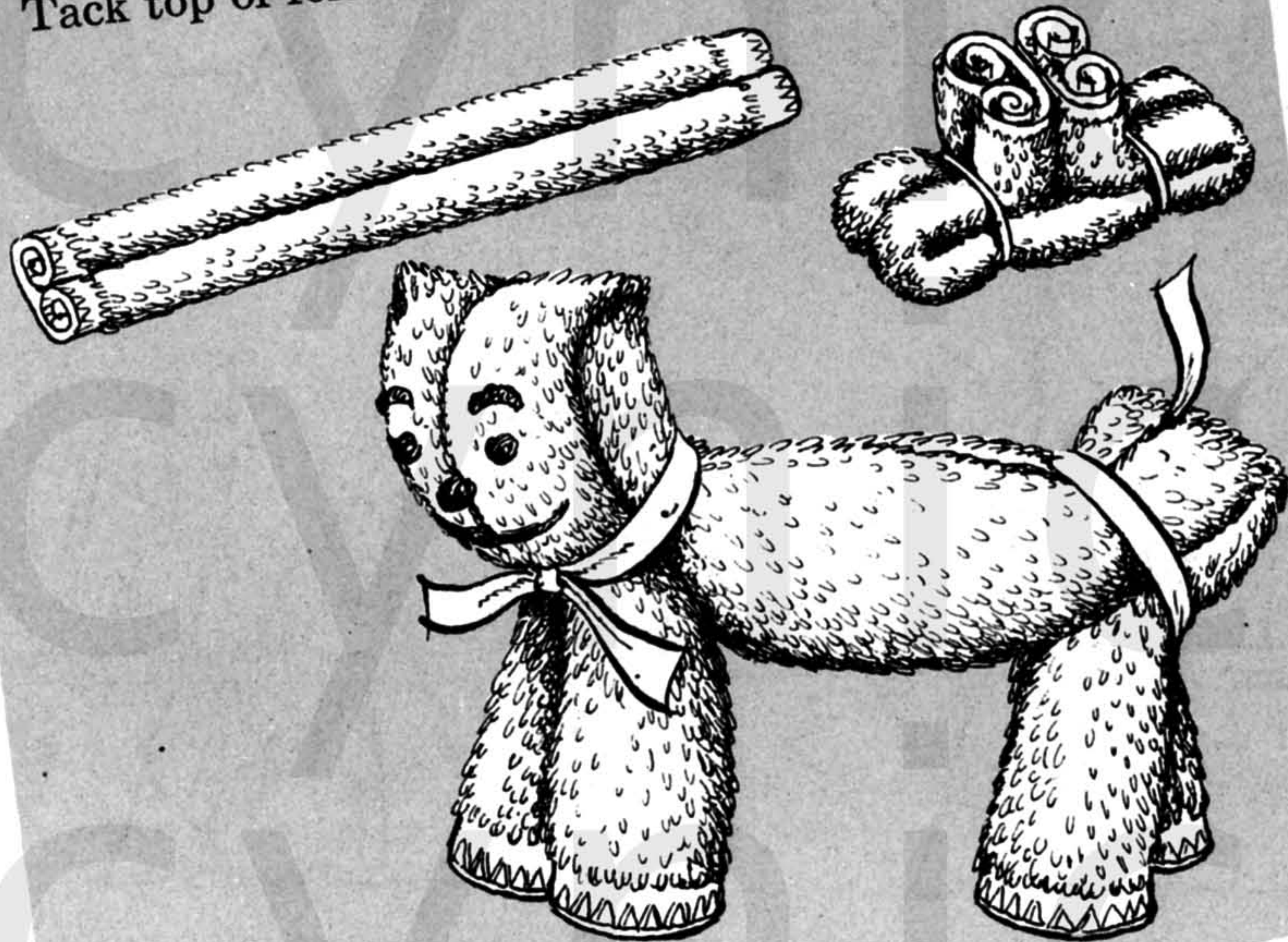

Mrs.





PRETTY

# Party Apron

Wear it for serving snacks. Gay as a carnival, if made from brightly striped kitchen towels.

You need: 2 Cannon kitchen towels 17" x 32" or 18" x 36", depending on size of wearer  
8 yards bias tape 1" wide  
Sewing thread to match

1. Fold one towel in half. Measure and cut triangle as shown.
2. Slash from point of triangle to edge of towel on one side only. Measure and stitch darts.
3. Bind cut edges with bias tape. Lap front over back at lower edges to form armhole. Pin.
4. Cut one towel in half crosswise. Stitch together, press seam open. Gather top to measure 17".
5. Cut a piece of bias tape  $3\frac{1}{4}$  yards long. Join raw ends in a seam. Stitch upper edge of bias tape to lower edge of top, wrong sides together. Stitch lower edge of bias tape to top of skirt, wrong sides together.
6. Turn apron to right side, pin bias tape over raw edges, extending ends about 15" on each side of top. Stitch all edges of bias tape.
7. Cut two pockets as shown. Bind upper edge with bias tape. Place pockets in position. Fold bias tape in half. Pin around pockets, covering raw edges. Stitch both edges of bias tape to apron.

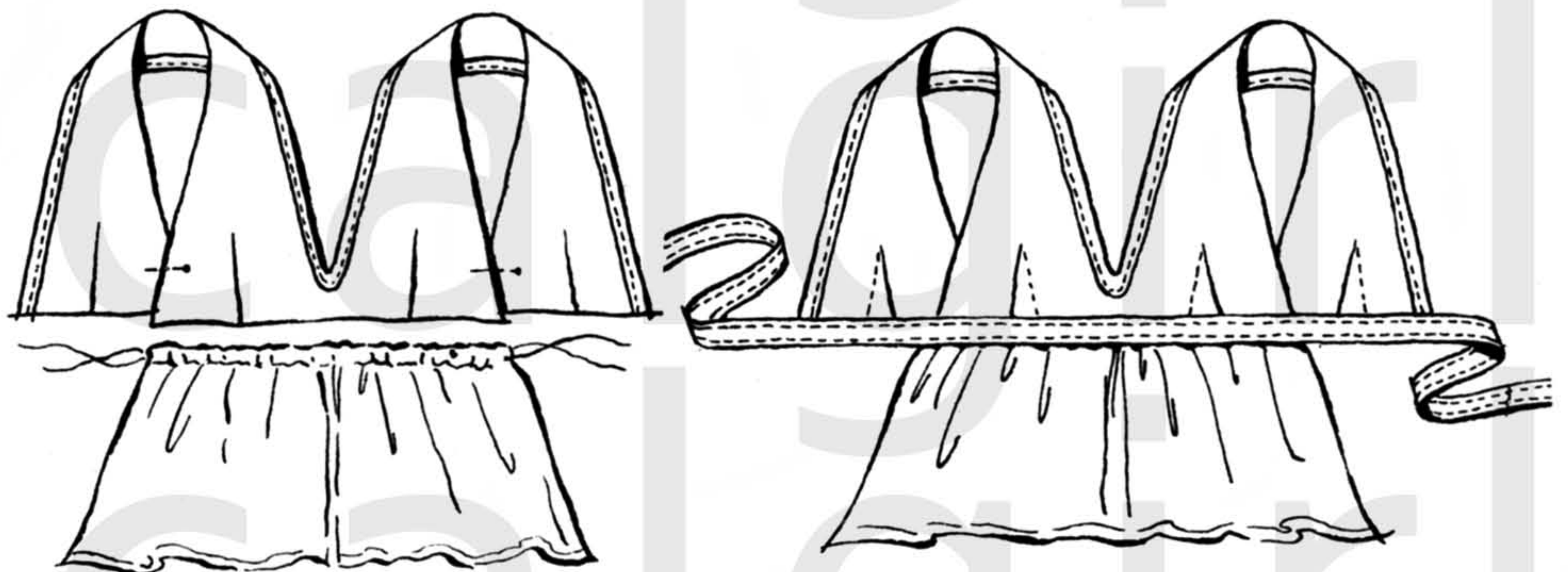
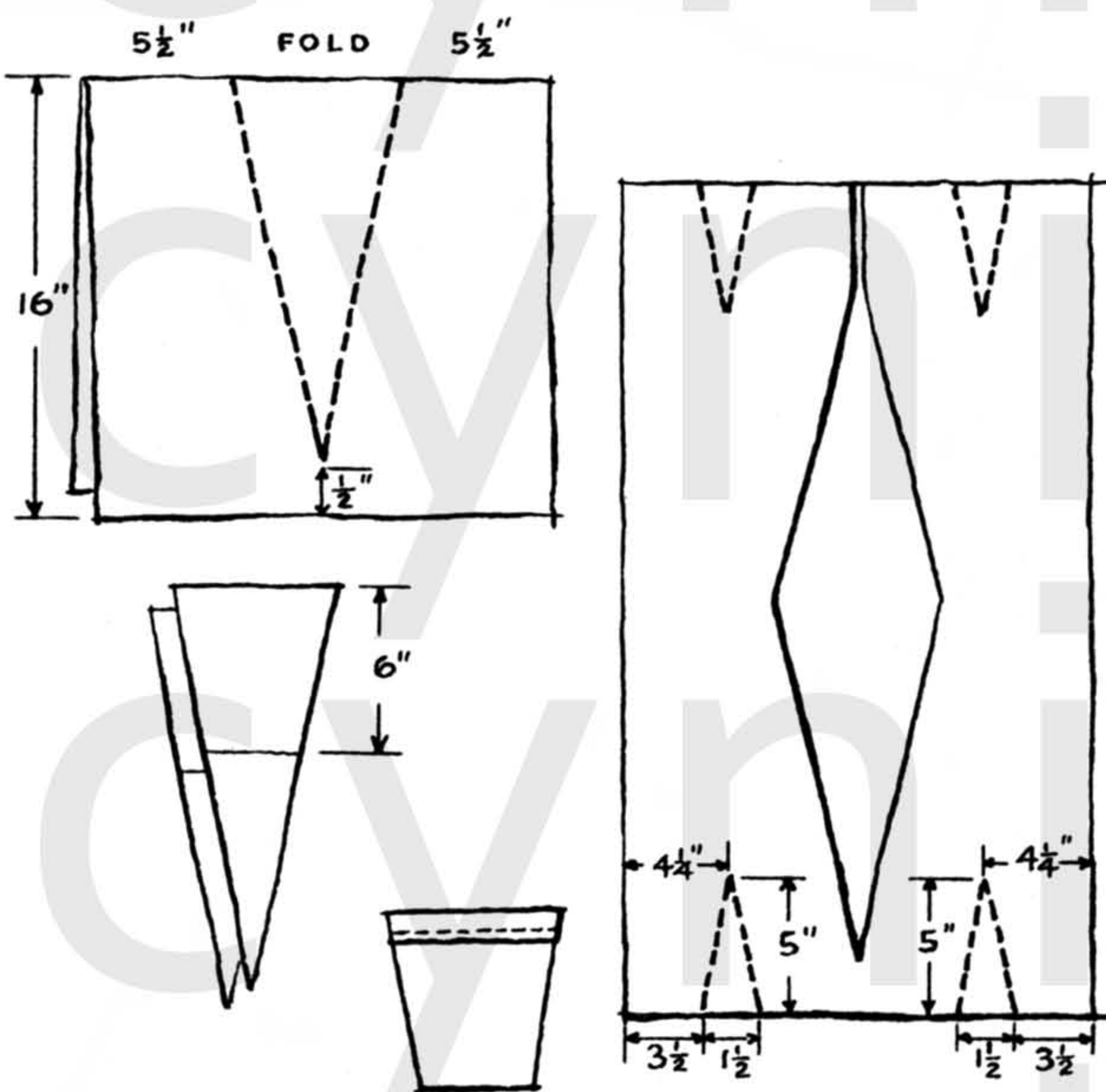

# Button Bottom Bag

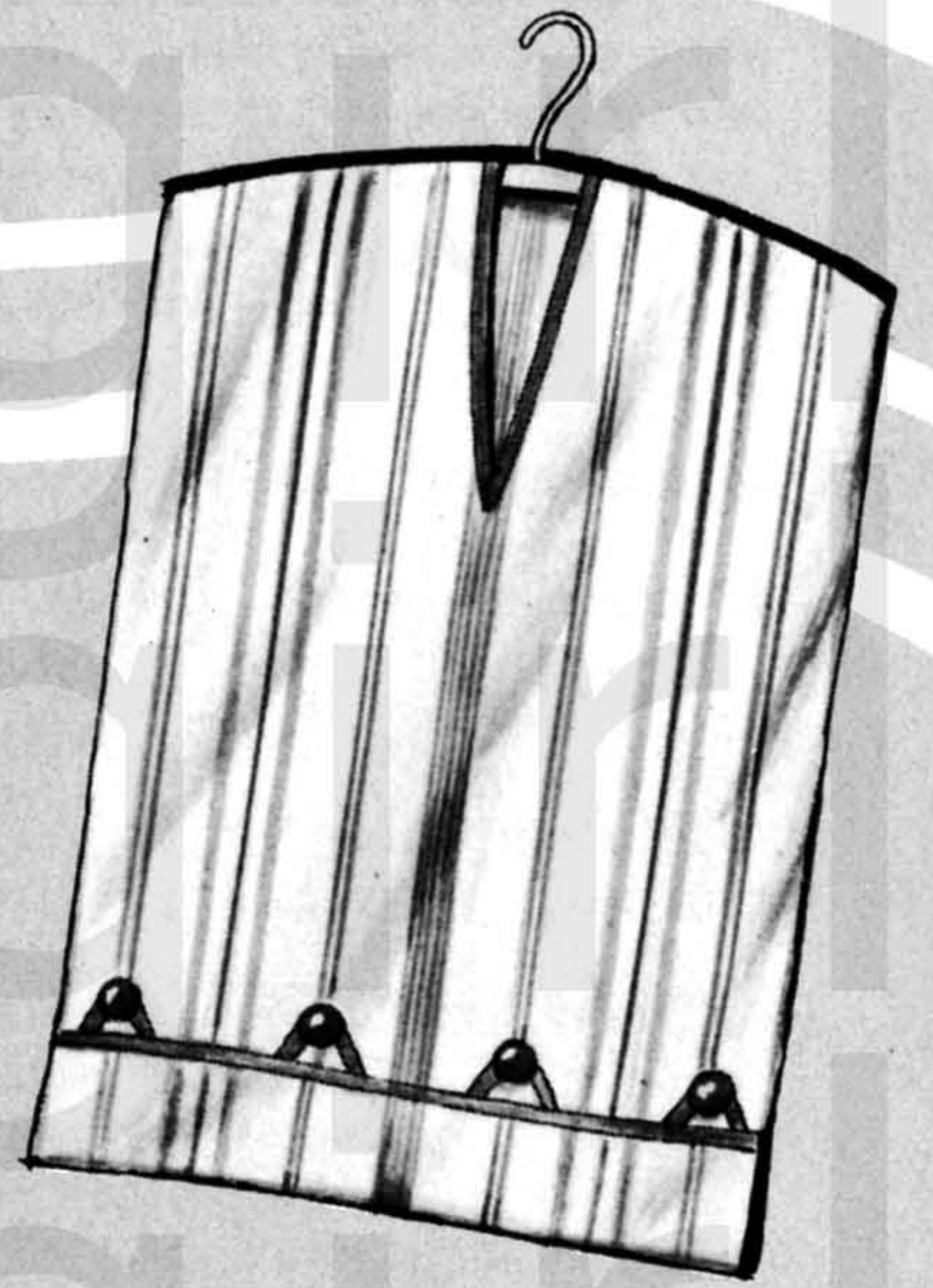

Two kitchen towels are all you need for this tricky laundry bag. Fill from the top and empty from the bottom. Hang it on a regular coat hanger. Select large size dish towels for lots of room. Bind with bright bias tape.

You need: 2 Cannon kitchen towels, 18" or 20" x 36"  
1 card bias tape  
4 buttons 1" size  
1 wooden coat hanger  
Sewing thread to match

1. Cut off 4" from the top of towel (A).
2. Cut an opening 10" long and  $\frac{1}{2}$ " on either side of center (A).
3. Place A on B, shape top as shown; bind opening.
4. Stitch shaped edges and sides together; bind shaped edge.
5. Cut a 12" strip of bias tape. Top stitch edges together. Cut into four equal parts. Shape in loops. Baste to inside of back, as shown.
6. Face lower edge with tape; fold back along bottom of front; sew buttons in place; slip hanger in opening.

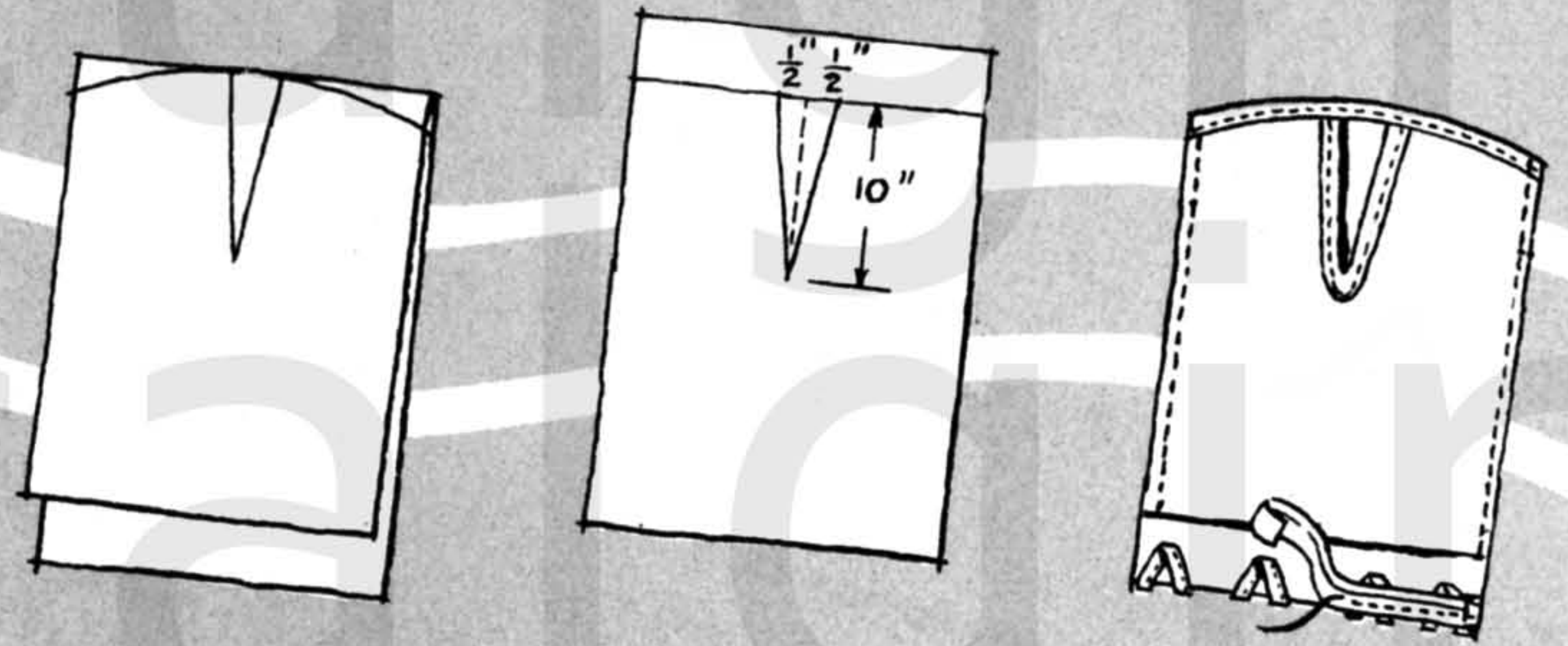

# Wear this Coat

## WHEN YOU'RE ALL WET...EMERGE NICE AND DRY

Wonderful for quick slip-on after bath or shower. Easy to make. Use towels with attractive borders for decoration.

You need: 2 Cannon bath towels 22" x 44" for sizes up to 14; larger towels for sizes 16 or over.

2 yards of heavy cable cord

$\frac{3}{4}$  yard bias tape

Sewing thread to match

1. Front Section: a. Cut one towel in half lengthwise.  
b. Face cut edge with tape for  $10\frac{1}{4}$ ".
2. Back Section—other towel  
a. Turn in selvage for  $10\frac{1}{4}$ ". Stitch.
3. Join fronts to back at sides. Make a flat felled seam, lapping selvage towards front on inside.
4. Join fronts to back at shoulder for  $7\frac{1}{2}$ ".
5. Fold points to outside and tack in place above border.
6. Attach cord at waist across back for about  $6\frac{1}{2}$ ".
7. Make a knot at ends of cord.
8. Fasten around waist.

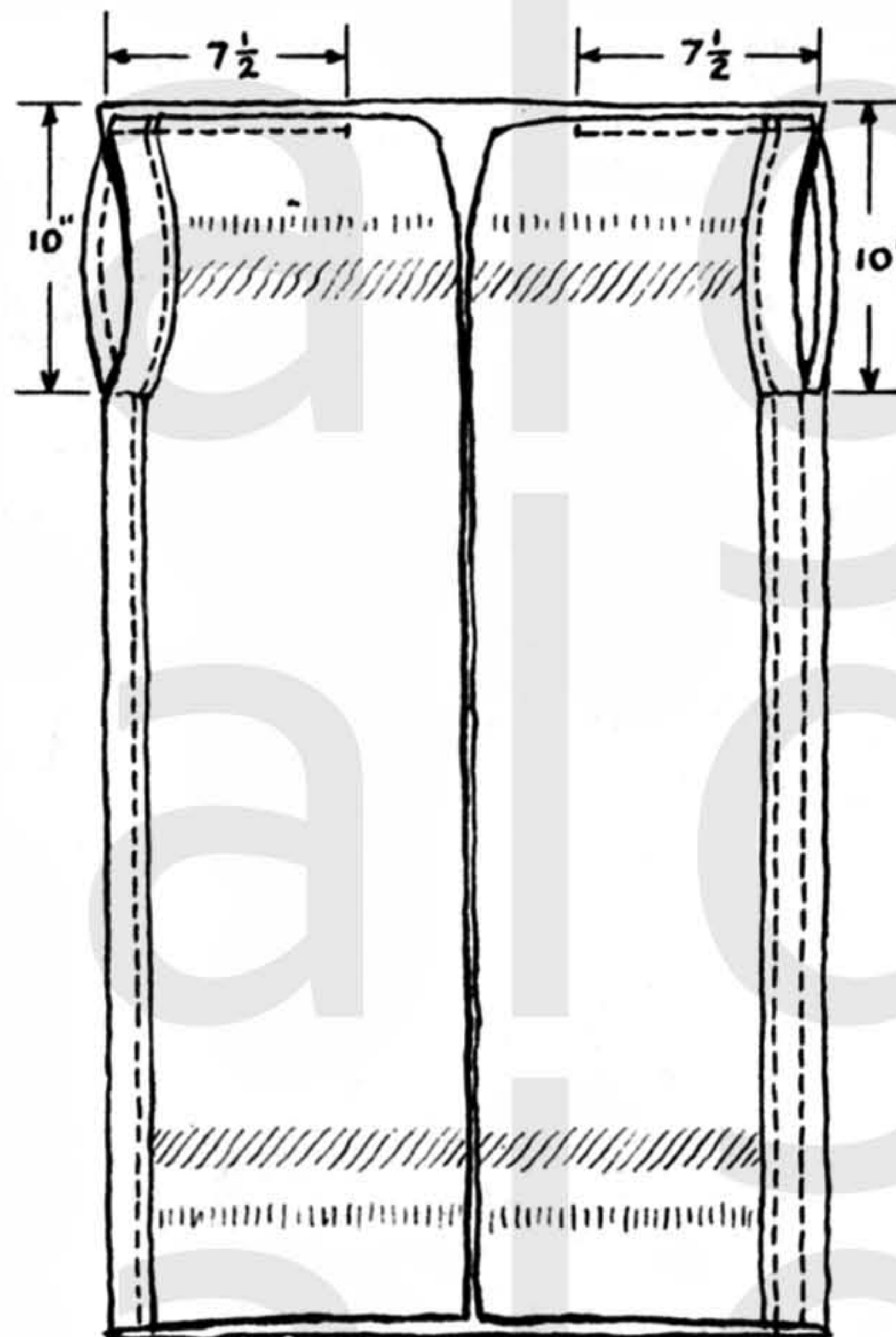

THIS

# Bag's On the Square

A cute trick . . . wonderful for beach, sports, knitting, general utility. The bag takes half a towel.

You need: 1 Cannon bath towel size 22" x 44"

1 piece plastic lining 22" x 22"

1 strip of crinoline  $5\frac{1}{2}$ " x  $5\frac{1}{2}$ "

2 yards narrow cable cord

4 bone rings  $\frac{3}{4}$ "

Sewing thread to match

1. Round edges of crinoline and stitch to center of plastic.
2. Cut towel in half crosswise. Turn in raw edge.
3. Place plastic lining to inside of towel. Stitch around all edges.
4. Stitch a narrow tuck around crinoline reinforcement.
5. Fold each side in half and stitch from fold for  $5\frac{1}{2}$ ".
6. Sew a ring to each free corner.
7. Slip cord through rings, each one in opposite direction.



MAKE A BIG HIT IN

# Your Terry Play Suit

MATCHING STOLE, BRA AND SHORTS

Make them of bright colored towels and washcloths. For stole, use fringe of white or contrasting cotton rug yarn.

Needed for Stole:

- 2 Cannon bath towels 20" x 40" or larger
- 2 7" slide-fasteners, for sectioned pockets at end of stole
- 1 hank contrasting color cotton yarn for fringe

Needed for Shorts:

- 2 Cannon bath towels 20" x 40" or larger (to fit up to size 18)
- Simplicity Pattern No. 2463
- Cotton rug yarn for monogram

Needed for Bra:

- 2 Cannon washcloths
- 2 1/2 yards cable cord

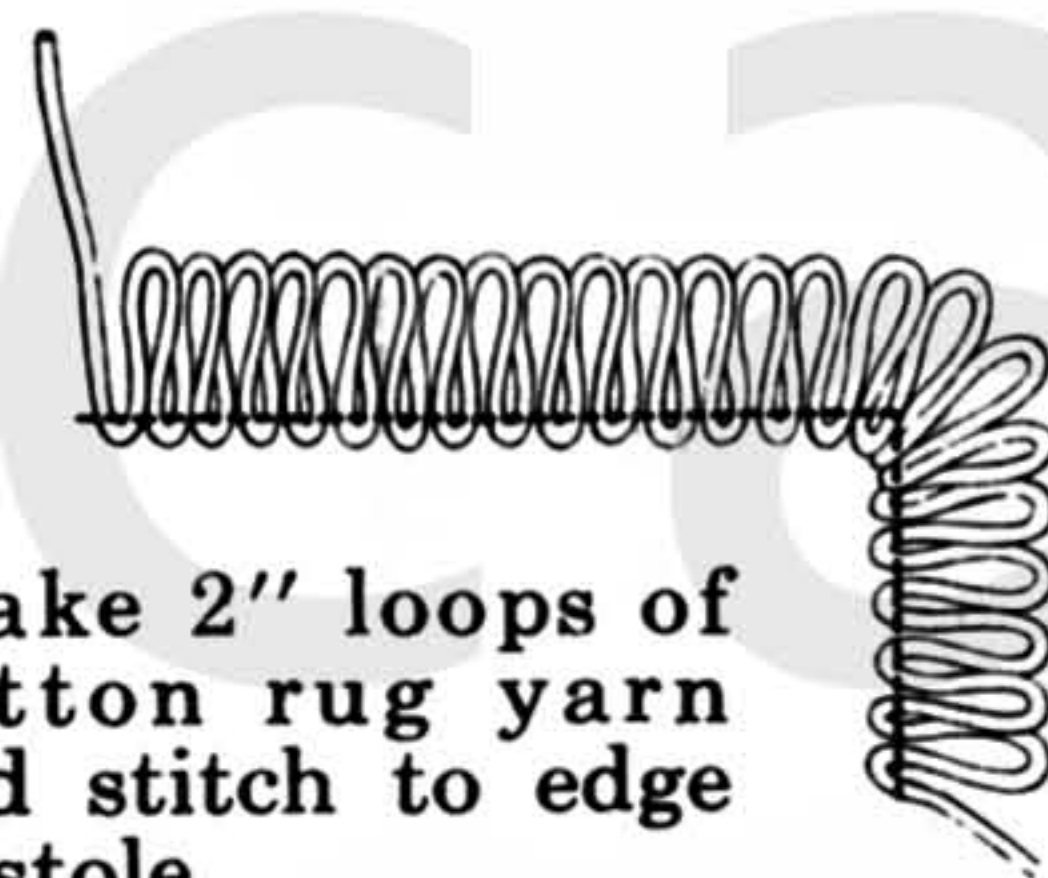
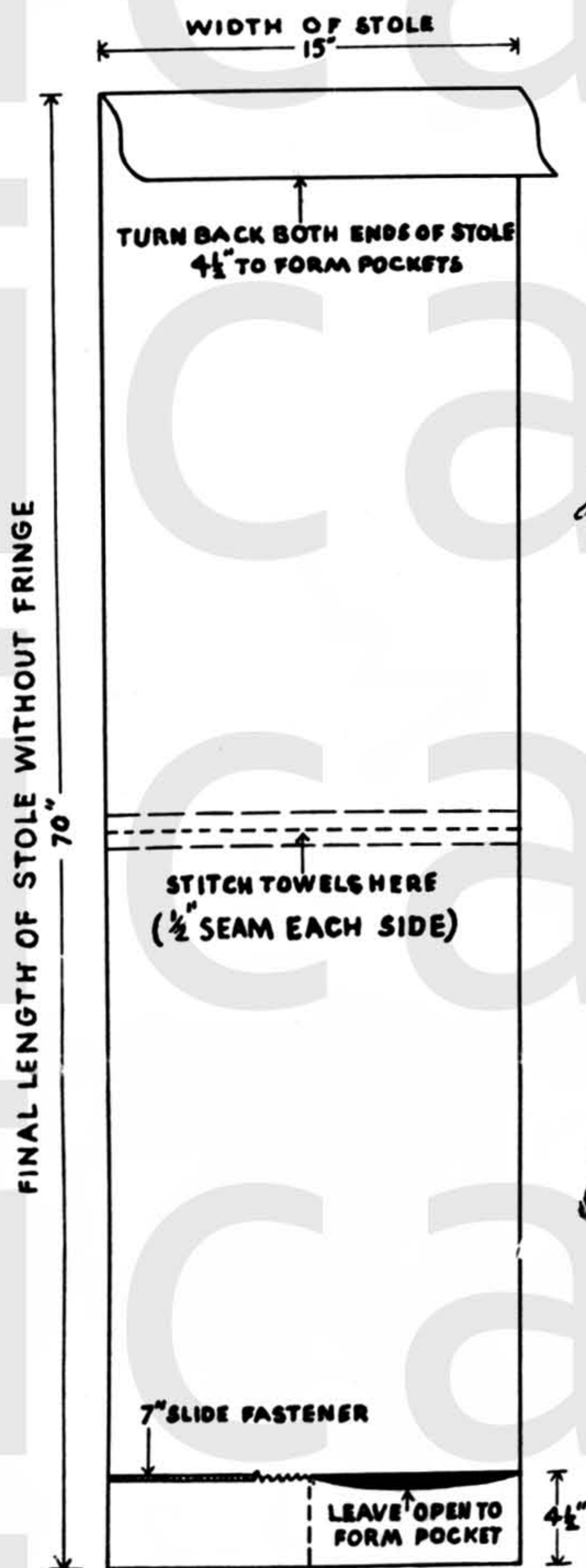
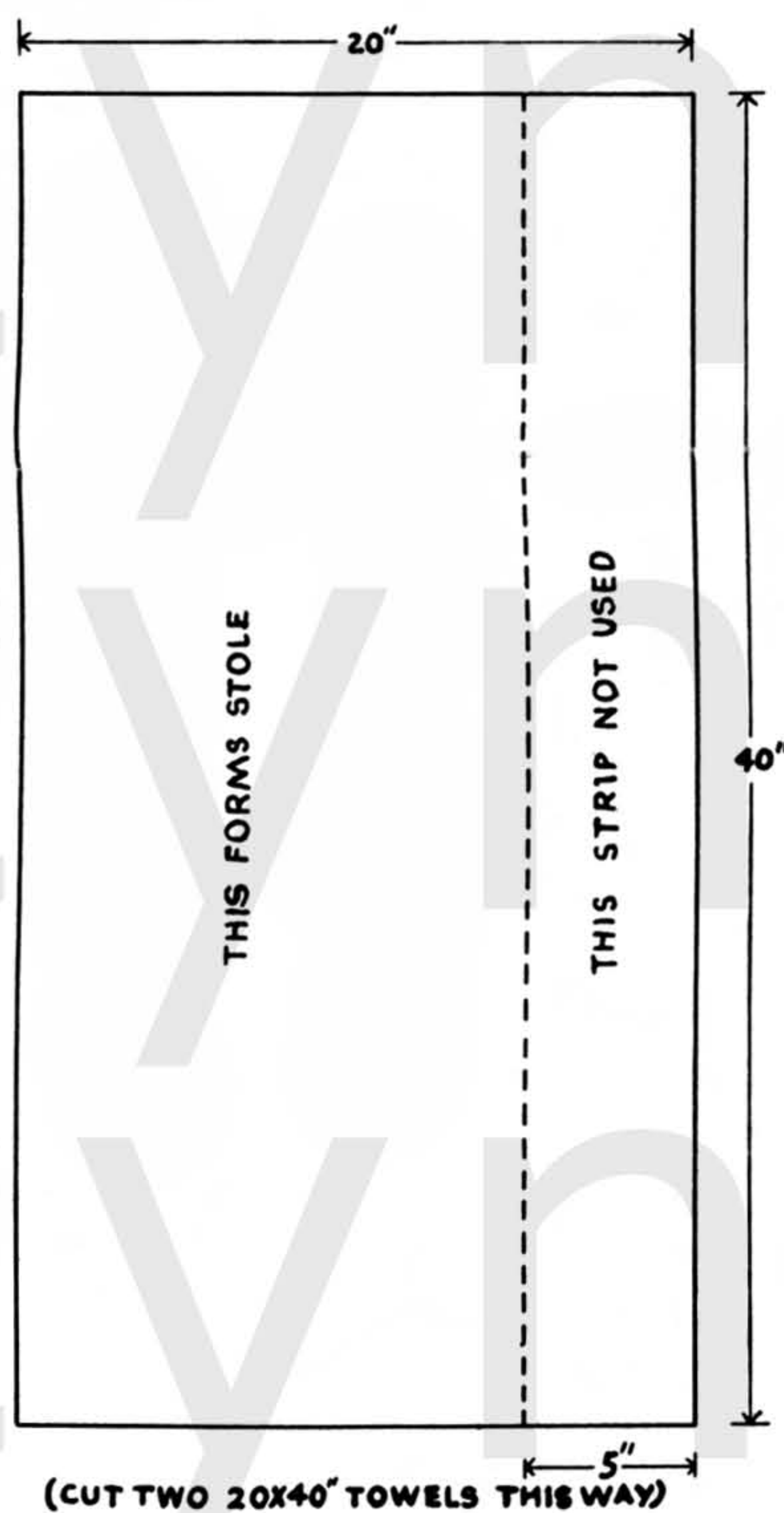

Make 2" loops of cotton rug yarn and stitch to edge of stole.

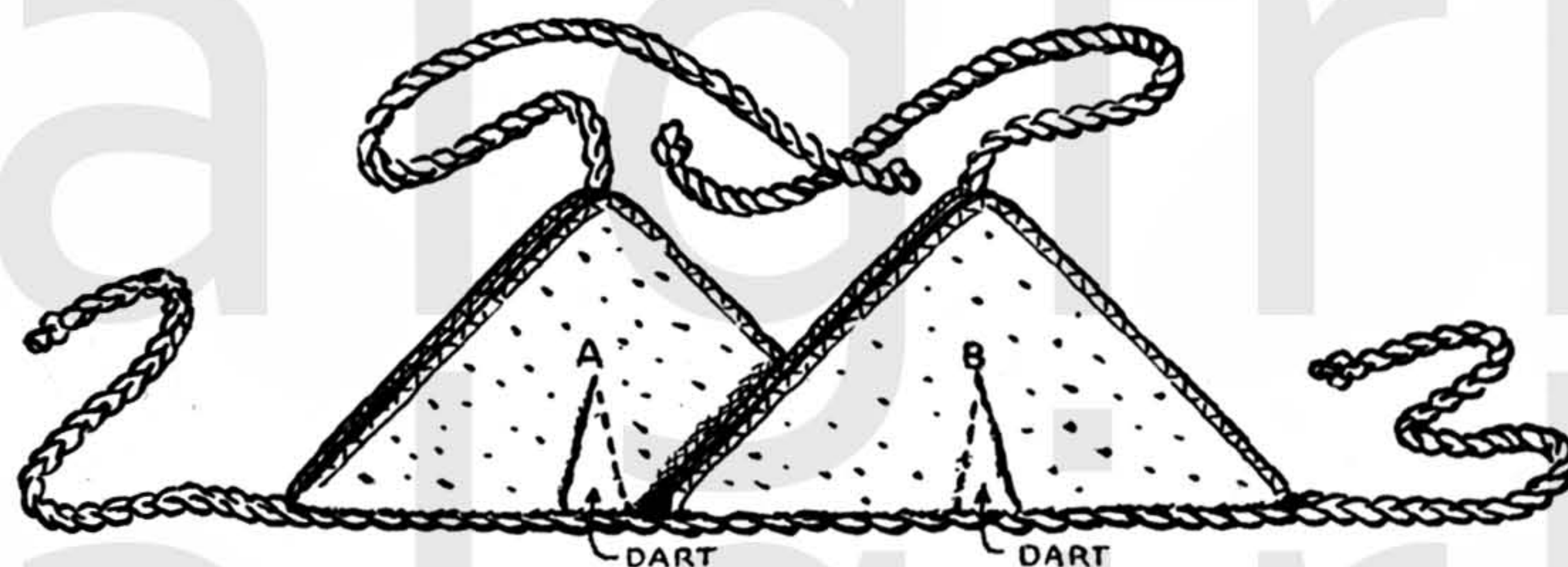

## HOW TO MAKE BRA:

1. Fold each washcloth in half to form a triangle.
2. Make a small dart in center of each triangle.
3. Place triangles so that point of washcloth A meets the dart on washcloth B. Pin.
4. Stitch cloths together around open edges.
5. Sew 1/2 yard cable to each top point, and whip 1 1/2 yards of cable to bottom, leaving enough loose at each end to tie in back.

